



ELECTRIC BLOWER VACUUM SHREDDER

RAC3000EB

USER GUIDE

WARNING: Read thoroughly the instruction manual before using.

CONTENTS

1. SAFETY INSTRUCTIONS.....	3
2. YOUR PRODUCT.....	14
3. ASSEMBLY.....	15
4. OPERATION.....	16
5. MAINTENANCE AND STORAGE.....	18
6. DISPOSAL.....	18
7. DECLARATION OF CONFORMITY.....	19
8. WARRANTY.....	20
9. PRODUCT FAILURE.....	21
10. WARRANTY EXCLUSIONS.....	22

1. SAFETY INSTRUCTIONS

Safe operating practices for hand-held mains-operated electrical garden vacuums, and garden blower/vacuums with or without shredding means and garden blowers

Training

- a) Read the instructions carefully. Be familiar with the controls and the correct use of the machine.
- b) Never allow children or people unfamiliar with these instructions to use the machine. Local regulations can restrict the age of the operator
- c) Keep in mind, that the operator or user is responsible for accidents or hazards occurring to other people or their property.

Preparation

- a) Obtain ear protection and safety glasses. Wear them at all times while operating the machine.
- b) While operating the machine always wear substantial footwear and long trousers. Do not operate the machine when barefoot or wearing open sandals. Avoid wearing clothing that is loose fitting or that has hanging cords or ties.
- c) Do not wear loose clothing or jewellery that can be drawn into the air inlet. Keep long hair away from the air inlets.
- d) Operate the machine in a recommended position and only on a firm, level surface.
- e) Do not operate the machine on a paved or gravel surface where ejected material could cause injury.
- f) Before using, always visually inspect to see, that the **shredding means, shredding means** bolts and other

fasteners are secure, the housing is undamaged and that **guards** and screens are in place. Replace worn or damaged components in sets to preserve balance. Replace damaged or unreadable labels.

- g) Before use, check the supply and extension cord for signs of damage or aging. If the cord becomes damaged during use, disconnect the cord from the supply immediately. **DO NOT TOUCH THE CORD BEFORE DISCONNECTING THE SUPPLY.** Do not use the machine if the cord is damaged or worn.
- h) Never operate the machine while people, especially children, or pets are nearby.

Operation

- a) Before starting the machine, make certain that the feeding chamber is empty.
- b) Keep your face and body away from the feed intake opening.
- c) Do not allow hands or any other part of the body or clothing inside the feeding chamber, discharge chute, or near any moving part.
- d) Keep proper balance and footing at all times. Do not overreach. Never stand at a higher level than the base of the machine when feeding material into it.
- e) Always stand clear of the discharge zone when operating this machine.
- f) When feeding material into the machine be extremely careful that pieces of metal, rocks, bottles, cans or other foreign objects are not included.
- g) If the cutting mechanism strikes any foreign objects or if the machine should start making any unusual noise or vibration, immediately shut off the power

source and allow the machine to stop. Disconnect the machine from the supply and take the following steps before restarting and operating the machine:

- inspect for damage;
 - replace or repair any damaged parts;
 - Check for and tighten any loose parts.
- h) Do not allow processed material to build up in the discharge zone; this may prevent proper discharge and can result in kickback of material through the intake opening.
- i) If the machine becomes clogged, shut-off the power source and disconnect the machine from supply before cleaning **debris**.
- j) Never operate the machine with defective **guards** or shields, or without safety devices, for example **debris collector** in place.
- k) Keep the power source clean of debris and other accumulations to prevent damage to the power source or possible fire.
- l) Do not transport this machine while the power source is running.
- m) Stop the machine, and remove plug from the socket. Make sure that all moving parts have come to a complete stop
- whenever you leave the machine,
 - before clearing blockages or unclogging chute,
 - Before checking, cleaning or working on the machine.
- n) Do not tilt the machine while the power source is running.

Maintenance and storage

- a) When the machine is stopped for servicing, inspection, or storage, or to change an accessory, shut off the power source, disconnect the machine from the supply and make sure that all moving parts are come to a complete stop. Allow the machine to cool before making any inspections, adjustments, etc. Maintain the machine with care and keep it clean.
- b) Store the machine in a dry place out of the reach of children.
- c) Always allow the machine to cool before storing.
- d) When servicing the shredding means be aware that, even though the power source is switched off due to the interlock feature of the guard, the shredding means can still be moved
- e) Replace worn or damaged parts for safety. Use only genuine replacement parts and accessories.
- f) Never attempt to override the interlocked feature of the guard.

Additional safety instructions for units with bagging attachments

Switch-off the machine before attaching or removing the bag.

Recommendation

The machine should be supplied via a residual current device (RCD) with a tripping current of not more than 30 mA.

Additional instructions

- This appliance is not intended for use by persons (including children) with reduced physical, sensory or mental capabilities, or lack of experience and

knowledge, unless they have been given supervision or instruction concerning use of the appliance by a person responsible for their safety.

- Children should be supervised to ensure that they do not play with the appliance.
- Never allow children, persons with reduced physical, sensory or mental capabilities or lack of experience and knowledge or people unfamiliar with these instructions to use the machine, local regulations may restrict the age of the operator.
- Never use the machine when people, especially children, or pets are nearby.
- Remember that the operator or user is responsible for accidents or hazards occurring to persons or their belongings.
- Before connecting, check:
 - Whether the tool and cable are not damaged. If damaged, do not use the machine and bring it back to your dealer for inspection and repair.
 - That the voltage on the rating plate of the tool matches with your electrical installation.
- Do not use accessories other than those recommended by the manufacturer; Non-recommended accessories can damage the unit and/or cause injuries.
- Do not disassemble the tool yourself. Disassembly, repair or inspection must be made exclusively by qualified personnel.
- Use the tool fully assembled and secure. Before using, check if the protections and safety devices are in place.

- During the operation of the machine, always wear protective equipment, including protective masks, visors or goggles, ear protection, helmet, gloves, non-slip footwear and protective clothing.
- Always carry the machine by its handle; never use the cord or any other part of the machine.
- Do not use the machine when you are tired, under the influence of alcohol or drugs or sick.
- Use the tool to suck and blow leaves and similar materials. Do not blow flammable materials, cigarette butts and materials that can damage the device.
- Do not use the appliance to suck water or wet debris.
- Always use the machine with the collection bag.
- Avoid using the machine in bad weather, especially when there is a risk of thunderstorms and lightning.
- In case of accident, immediately stop using the machine. Turn off and unplug it and check the problem. Do not use the machine while the machine is damaged.
- Do not use the tool if you are drunk, tired, under the influence of drugs or ill. Do not use the tool if you are not in an adequate physical condition
- Do not use the tool during bad weather conditions (lighting, rain, storm, big winds, etc.)
- Do not use the tool in an area where ventilation is poor. Gas emissions can cause injury.
- Do not use the tool in damp locations.
- Do not use the tool in the presence of flammable liquids or gases.
- Do not operate the product with damaged guards or shields not in place.

- Do not lean. Keep a good balance at all times.
- Keep handles dry, clean and free from oil and grease.
- Use and handle the machine carefully.
- Do not put your body, clothes or shoes close to the air opening
- Do not lift up the tool when it is in operation.
- Do not point the tool in front of people; this can lead to accidents and injuries.
- Do not put any objects inside the tube and inside the tool.
- Before using the product and after any shock, please check it for signs of wear or damage.
- Please carry out repairs if necessary.
- Inspect and regularly service the product. Repairs should be carried out only by an authorized service center or a similarly qualified specialist.
- Children should not play with plastic bags, sheets and small parts! Keep them out of the reach of children. There is a danger of swallowing and suffocation!
- Do not use the product on a slippery surface.
- Do not use the product on steep, slippery slopes. If you need to work on slopes, use an extreme care and be careful about your footing. Please wear non slippery footwear.
- When planning your work schedule, allow enough time for rest. Limit continuous use of the device, e.g. use 30 ~ 40 minutes per session, and take 10 ~ 20 minutes of rest between work sessions. Work a maximum of two hours per day.
- Do not connect a damaged cord to supply or touch a damaged cord before it is disconnected from the

supply; damaged cords can lead to contact with live parts.

- Keep extension cords away from moving hazardous parts to avoid damages to the cords which can lead to contact with live parts.
- When a cable is damaged or entangled, please stop immediately to use the tool. Switch off the tool, let it cool and unplug it in a secure way.
- When operating a power tool outdoors, use an extension cord suitable for outdoor use. Use of a cord suitable for outdoor use reduces the risk of electric shock.
- Use extra care when using on stairs.
- In dusty conditions, slightly dampen surfaces or use mister attachment if available
- Use the full blower nozzle extension so the air stream can work closer to the ground
- Never use the appliance for spreading chemicals, fertilizer, or any other substances that may contain toxic materials. Do not use appliance as a sprayer of flammable liquids.
- Keep all the air intakes and the blower tube free of dust, lint, hair and other material that may cause a reduction in air flow.
- Do not switch on the tool in enclosed or poorly ventilated spaces or in the presence of inflammable and/or explosive substances such as liquids, gasses, and powders.)
- Disconnect electrical supply before opening inlet cover or installing pick up tubes. Never operate unit without inlet cover secured or pick-up tubes in place.



- Always inspect the area before starting the appliance to remove debris and hard or sharp objects that can be blown or cause damaged during operation
- Never operate this appliance when you are tired, ill or under the influence of alcohol, drugs or medication.
- Always run the appliance with the blower tubes attached to the unit.
- Always work moving away from solid objects such as walls, large stones, automobiles and fences.
- Clean spaces with corners by starting in corners and moving outward to straight areas to prevent an accumulation of debris, which could fly into face.
- Be careful when working near valuable plants. The force of air could damage tender plants.
- Uses for your blowers: sweeping debris or grass clippings from driveways, sidewalks, patios, parks, parking lots, barns, etc. Gathering grass clippings, straw or leaves into piles. Removing debris from corners, around joints and between bricks.
- Stay alert. Watch what you are doing and use common sense when operating a power tool. Do not operate tool when you are tired or under the influence of drugs, alcohol or medication. A moment of inattention while operating power tools may result in serious personal injury.







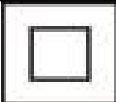

Residual risks

Even if you use this product in compliance with all safety requirements, the potential risks of injury and damage remain. The following hazards may arise in the structure and design of this product:

- a. There are harmful health consequences resulting from the emission of vibrations if the product is used for long periods of time or not properly managed and properly maintained.
- b. Risk of injury to persons and property caused by flying objects.
- c. Prolonged use of this product exposes the operator to vibration and can produce so-called "white finger" disease. To reduce the risk, wear gloves and keep your hands warm.
- d. If any of the symptoms of "white finger syndrome" occur, seek immediate medical attention. Symptoms of the "white finger" include numbness, loss of sensitivity, tingling, and pain, loss of strength, colour changes or skin condition. These symptoms usually appear on the fingers, hands or wrists. Risk increases at low temperatures.
- e. Inhalation of particles of material blown/vacuumed
- f. Unattended projections
- g. Contact with foreign objects
- h. Contact with the tool in operation
- i. Hearing loss in the absence of correct hearing protection

Explanation of symbol

	<p>Denotes risk of personal injury, loss of life, or damage to the tool in case of non-observance.</p>
	<p>Conforms to all relevant EC Directives.</p>
	<p>Read instruction manual before operating or attempting any maintenance work.</p>

	This product is double insulated electrically.
	SWITCH OFF: Remove plug from mains before cleaning or maintenance.
	Do not use in the rain or leave outdoors while it is raining.
	Wear eye protection, ear muffs.
	Warning. Moving blades. Keep hands and feet away when the machine is operated.
	Keep bystanders away.
	Guarantee sound power level.
	Remove plug from the mains immediately if the cable is damaged or cut.

Intended use

This vacuum blower is intended to be used for the vacuuming and the blowing of leaves, dust, and similar little materials. It must not to be used for vacuuming and blowing water, chemical products, flammable material, metal or wood and others dangerous objects.

- This product is intended for private domestic use only. It must be used outdoors.
- This product is not intended to be used in a closed room or in places where exhausted gas and flames can be present.
- The use of this product in case of rain or humid environment is prohibited.
- Use this vacuum blower only as described in this manual and only for the intended use as described above.
- Any other use might lead to damage of the appliance, property or personal injury.
- No liability will be accepted for damage resulting from improper use or non-compliance with this manual.

2. YOUR PRODUCT

a. Description

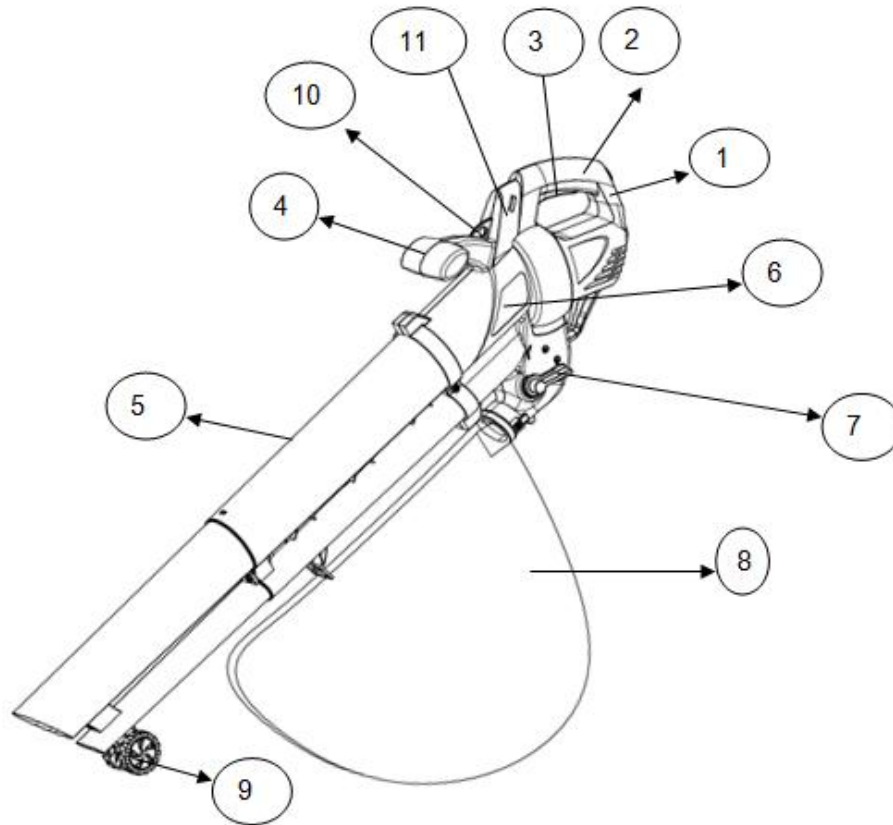

- | | |
|------------------|-------------------------------------|
| 1. Supply cable | 7. Function switch (blower/vacuum) |
| 2. Main handle | 8. Collection bag |
| 3. On/off switch | 9. Wheel |
| 4. Front handle | 10. Attachment for shoulder harness |
| 5. Blower tube | 11. Speed control roller |
| 6. Motor housing | |

b. Technical specifications

Model	RAC3000EB
Rated input power	3000W
Rated no-load speed	15000/min
Rated Voltage	230-240V~50Hz
Blower velocity	250 km/h
Maximum blower air output	10.7m ³ /min
Collecting bag capacity	40L
Weight	2.78Kg
Sound pressure level	LpA: 90.8dB(A) K=3 dB(A)
Sound power level	LwA,m: max.103.7dB(A) K=3 dB(A)
Guarantee sound power level	LwA: 107dB(A)
Vibration	Front handle: 4.21m/s ² K= 1,5m/s ² Rear handle: 3.78m/s ² K= 1,5m/s ²

3. ASSEMBLY

a. Tube assembly

- Slide the upper tube into the motor housing, then tighten the screws and make sure the tube is firmly fixed with motor housing.

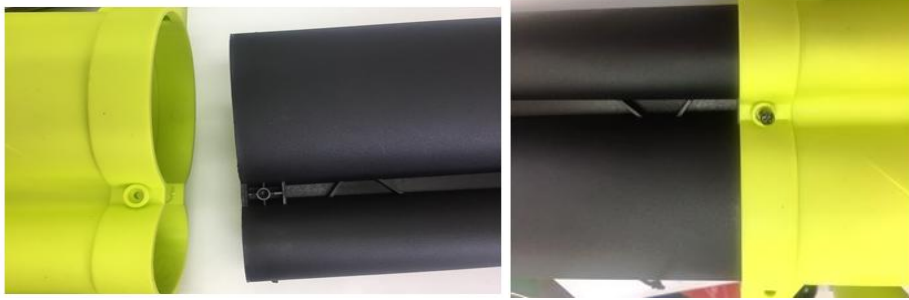

- Insert the 2 lower tubes (one into upper tube and the smaller below) and push them until they are connected firmly together. Use the provided plate and two screws to fix the tubes together.

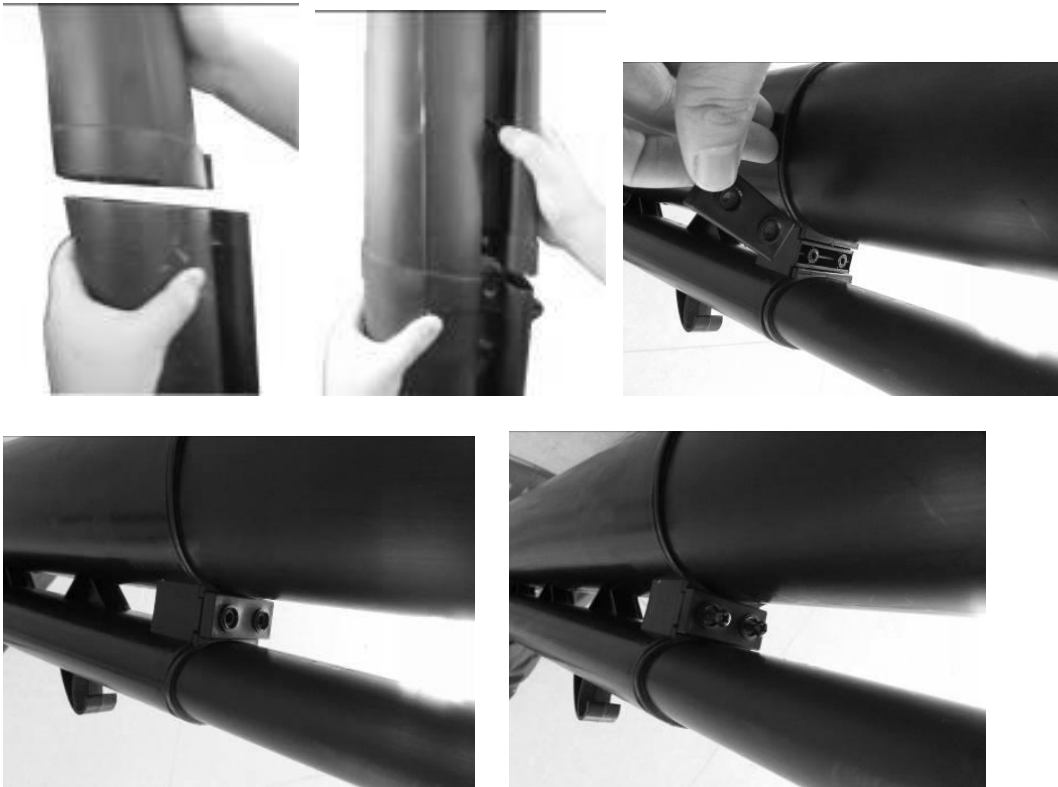

- Assemble the wheels to the lower tube. Add one wheel on each side of the hole situated on smaller lower tube. Fix the wheels together with the screw and the nut. Then fix the provided two plates and screws to fix the tubes together.

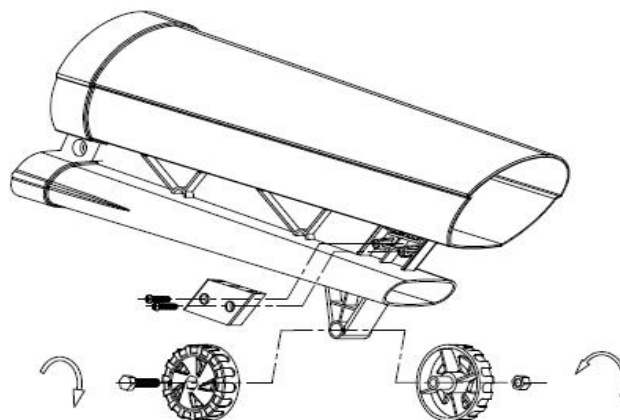

Caution: In the interests of safety the tubes should not be dismantled after they have been assembled.

- Attach the collect bag to the hook on upper tube and the outlet on the bottom of motor housing.



4. OPERATION

Before starting the machine, make sure that collect bag is fitted and the shoulder harness is adjusted to a suitable working position.

a. Extension cable

The tool must be connected to an extension cable. Plug the cable of the tool into extension cable. Then, attach the extension to the cable holder to hold it.

The extension cable shall not be lighter than the standardised code H05 RN-F/H05 VV-F. See your retailer or manufacturer for more advice.

b. Switching on and off the tool

Before start the tool, be sure that the speed control knob is on the position 1 (lower position).

- To switch on, press the ON/OFF switch (fig 2a).
- To stop the tool, release the ON/OFF switch (fig 2b).



2a



2b

c. Speed Control

You can adjust the power of the air flow with the control knob. The power goes to 1 to 6 (from the lower to the highest power).

Turn the knob to adjust the power of the airflow, according the work performed.

When stop to use the machine, put the knob to the position 1.



d. **Blowing mode**

Blowing mode can be used for cleaning corners, fences, walls, wooden areas or beneath cars. Be careful what you point the jet of air as it could move heavy material and cause injury or damage.

- Inspect the work area before starting. Remove any debris or objects that could be thrown or those that can get caught or obstruct the device.
- Put the shoulder strap.
- Push down the lever to choose the blowing mode.

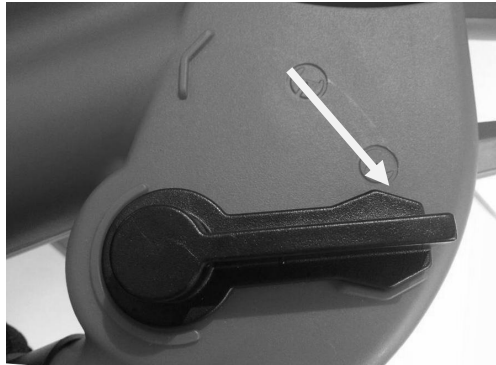

- Hold the machine by the handle. Walk and hold the tube just above the ground and blow the debris.
- Switch on the tool by pushing and holding the ON/OFF switch.
- Work in order to gather the debris in one or more lots. Use the vacuum mode to collect the heap. You can also pick up the pile of debris with a broom (or rake) and a shovel.
- When the operation is finished, release the ON/OFF switch.
- Throw away the debris in a trash bin.

e. **Vacuum mode**

- Inspect the work area before starting. Remove any debris or objects that could be thrown or those that can get caught or obstruct the device.
- Put the shoulder strap.
- Push up the lever to choose the vacuum mode.



- Make sure that the collect bag is fitted properly.
- Switch on the tool by pushing and holding the ON/OFF switch.
- Put the tube to the ground without putting it in the debris. Move while sucking debris
- When the collection bag is filled, stop working and empty the bag.

When the collect bag is full, the vacuum power will be greatly reduced. When this happens, turn the switch to position “1” and disconnect the plug from the electricity supply. Wait until the suction fan has stopped completely before operation. Open the zip fastener inside the bag; spread out the opening and empty it completely. If you have collected only leaves or vegetable matter, they will already have been shredded and will be ready for composting. Zip up the bag and resume work.

Note: Before re-fitting the bag, clean the inside of the exhaust opening, removing any shredded deposits. Pay special attention to the cleaning of the supporting edges of the air flow deviator on the inside of the tube.

5. MAINTENANCE AND STORAGE

WARNING! Do not use products that can damage the device (abrasive, corrosive, alcohols, steam cleaners, abrasive cloths, scrapers, etc.).

Do not install the appliance in a dishwasher for cleaning!

The unit must be completely switched off, unplugged, and cool before cleaning.

a. Care

After each use:

- Remove the collection bag and empty its contents into a dustbin.
- Use a brush to remove debris from fan and inside the tube.
- If necessary, you can clean the body of the tool with a soft dry cloth.

b. Maintenance

After each use:

- Check all nuts, bolts and screws are tight and that the safety devices are properly positioned.
- Check if the machine has not suffered damage. If the machine is damaged, you will need to hire a qualified technician to inspect the machine and makes repairs.

c. Storage

- Always clean the tool before storage.
- The tool, tube and collector bag must be stored in a well-ventilated place, stable and plane.
- The tool must be out of the reach of children.

6. DISPOSAL



Electrical products should not be discarded with household products. According to the European Directive 2012/19/EC on waste electrical and electronic equipment and its implementation into national law, electrical products used must be collected separately and disposed of at collection points provided for this purpose. Talk with your local authorities or dealer for advice on recycling.

7. DECLARATION OF CONFORMITY



BUILDER SAS

ZI, 32 rue, Aristide Bergès – 31270 Cugnaux - France

Tel: +33 (0)5.34.502.502 Fax: +33 (0)5.34.502.503

States that the designated below machine:

ELECTRIC BLOWER VACUUM SHREDDER

RAC3000EB

Serial number: 20230704531-20230705030

Developed, designed and manufactured in accordance with the requirements of directives:

Machinery Directive 2006/42/EC

EMC Directive 2014/30/EC

ROHS Directive (EU)2015/863 amending 2011/65/EU

Directive Noise 2000/14/EC Annex V and 2005/88/EC

Sound power level: max 103.7dB(A) K=3 dB(A)

Guarantee sound power level: 107dB(A)

Also meets the following standards

EN 60335-1:2012/A2:2019

EN50636-2-100:2014

EN62233:2008

EN IEC55014-1:2021

EN IEC55014-2:2021

EN IEC61000-3-2:2019/A1:2021

EN 61000-3-3:2013/A2:2021

Philippe MARIE/PDG

Cugnaux, 25/05/2023

Responsible of the technical file: Mr Olivier PATRIARCA

8. WARRANTY



WARRANTY

The manufacturer guarantees the product against defects in material and workmanship for a period of 2 years from the date of the original purchase. The warranty only applies if the product is for household use. The warranty does not cover breakdowns due to normal wear and tear.

The manufacturer agrees to replace parts identified as defective by the designated distributor. The manufacturer does not accept responsibility for the replacement of the machine, in whole or in part, and/or ensuing damage.

The warranty does not cover breakdowns due to:

- insufficient maintenance.
- abnormal assembly, adjustment or operations of the product.
- parts subject to normal wear and tear.

The warranty does not extend to:

- shipping and packaging costs.
- using the tool for a purpose other than that for which it was designed.
- the use and maintenance of the machine done in a manner not described in the user manual.

Due to our policy of continuous product improvement, we reserve the right to alter or change specifications without notice. Consequently, the product may be different from the information contained therein, but a modification will be undertaken without notice if it is recognized as an improvement of the preceding characteristic.

READ THE MANUAL CAREFULLY BEFORE USING THE MACHINE.

When ordering spare parts, please indicate the part number or code, you can find this in the spare parts list in this manual. Keep the purchase receipt; without it, the warranty is invalid. To help you with your product, we invite you to contact us by phone or via our website:

- **+33 (0)9.70.75.30.30**
- **<https://services.swap-europe.com/contact>**

You must create a "ticket" via the web platform.

- Register or create your account.
- Indicate the reference of the tool.
- Choose the subject of your request.
- Describe your problem.
- Attach these files: invoice or sales receipt, photo of the identification plate (serial number), photo of the part you need (for example: pins on the transformer plug which are broken).



9. PRODUCT FAILURE

WHAT TO DO IF MY MACHINE BREAKS DOWN?

If you bought your product in a store:

- a) Empty the fuel tank if your product has one.
- b) Make sure that your machine is complete with all accessories supplied, and clean! If this is not the case, the repairer will refuse the machine.

Go to the store with the complete machine and with the receipt or invoice.

If you bought your product on a website:

- a) Empty the fuel tank if your product has one.
- b) Make sure that your machine is complete with all accessories supplied, and clean! If this is not the case, the repairer will refuse the machine.
- c) Create a SWAP-Europe service ticket on the site: <https://services.swap-europe.com> When making the request on SWAP-Europe, you must attach the invoice and the photo of the nameplate (serial number).
- d) Contact the repair station to make sure it is available before dropping off the machine.

Go to the repair station with the complete machine packed, accompanied by the purchase invoice and the station support sheet downloadable after the service request is completed on the SWAP-Europe site

For machines with engine failure from manufacturers BRIGGS & STRATTON, HONDA and RATO, please refer to the following instructions.

Repairs will be done by approved engine manufacturers of these manufacturers, see their site:

- <http://www.briggsandstratton.com/eu/fr>
- <http://www.honda-engines-eu.com/fr/service-network-page;jsessionid=5EE8456CF39CD572AA2AEEDFD290CDAE>
- <https://www.rato-europe.com/it/service-network>

Please keep your original packaging to allow for after-sales service returns or pack your machine with a similar cardboard box of the same dimensions.

For any question concerning our after-sales service you can make a request on our website <https://services.swap-europe.com>

Our hotline remains available at +33 (9) 70 75 30 30.



10. WARRANTY EXCLUSIONS

THE WARRANTY DOES NOT COVER:

- Start-up and setting up of the product.
- Damage resulting from normal wear and tear of the product.
- Damage resulting from improper use of the product.
- Damage resulting from assembly or start-up not in accordance with the user manual.
- Breakdowns related to carburetion beyond 90 days and fouling of carburetors.
- Periodic and standard maintenance events.
- Actions of modification and dismantling that directly void the warranty.
- Products whose original authentication marking (brand, serial number) has been degraded, altered or withdrawn.
- Replacement of consumables.
- The use of non-original parts.
- Breakage of parts following impacts or projections.
- Accessories breakdowns.
- Defects and their consequences linked to any external cause.
- Loss of components and loss due to insufficient screwing.
- Cutting components and any damage related to the loosening of parts.
- Overload or overheating.
- Poor power supply quality: faulty voltage, voltage error, etc.
- Damages resulting from the deprivation of enjoyment of the product during the time necessary for repairs and more generally the costs related to the immobilization of the product.
- The costs of a second opinion established by a third party following an estimate by a SWAP-Europe repair station
- The use of a product which would show a defect or a breakage which was not the subject of an immediate report and/or repair with the services of SWAP-Europe.
- Deterioration linked to transport and storage*.
- Launchers beyond 90 days.
- Oil, petrol, grease.
- Damages related to the use of non-compliant fuels or lubricants.

* In accordance with transport legislation, damage related to transport must be declared to carriers within 48 hours maximum after observation by registered letter with acknowledgement of receipt.

This document is a supplement to your notice, a non-exhaustive list.

Attention: all orders must be checked in the presence of the delivery person. In case of refusal by the delivery person, it you must simply refuse the delivery and notify your refusal.

Reminder: the reserves do not exclude the notification by registered letter with acknowledgement within 72 hours.

Information: Thermal devices must be wintered each season (service available on the SWAP-Europe site). Batteries must be charged before being stored.



BUILDER SAS

32 rue Aristide Bergès - Z.I. du Casque - 31270 Cugnaux - France

MADE IN PRC